

Technics®

How to use the remote control transmitter EUR643809



Battery notes

Do not mix old and new batteries, or batteries of different types (carbon and alkaline, etc.).

Always remove old, weak or worn-out batteries promptly and dispose of them properly.

The average battery life is about one year. Although the battery life varies depending on how often the device is used, you should generally replace the batteries about once a year.

The batteries should be replaced if commands from the remote control transmitter do not operate the unit even when the transmitter is held close to the front panel.

Never subject batteries to excessive heat or flame; do not attempt to disassemble them; and be sure they are not short-circuited.

If you will not use the remote control for a long period of time, remove the batteries and store them in a cool, dark place.

If a battery leaks, remove all batteries and dispose of them properly. Thoroughly clean the battery compartment before inserting new batteries.

If the leaking electrolyte comes into contact with skin or clothes, flush with water immediately.

Keep batteries out of reach of children.

Do not use rechargeable type batteries.

Do not attempt to recharge alkaline or carbon batteries.

Do not dispose of used batteries in household rubbish.

P

Before use

Battery installation

Insert the batteries included with this unit as shown below.

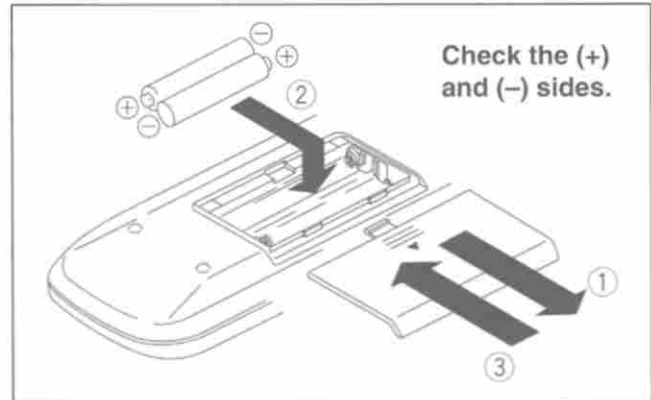

When you need to replace these batteries

Use two R03/LR03, AAA, UM-4 (1.5 V) or equivalent batteries.

Method for use

Use the remote control within 60 degrees and within 7 meters (23 ft.) facing directly toward the changer's remote control signal sensor.

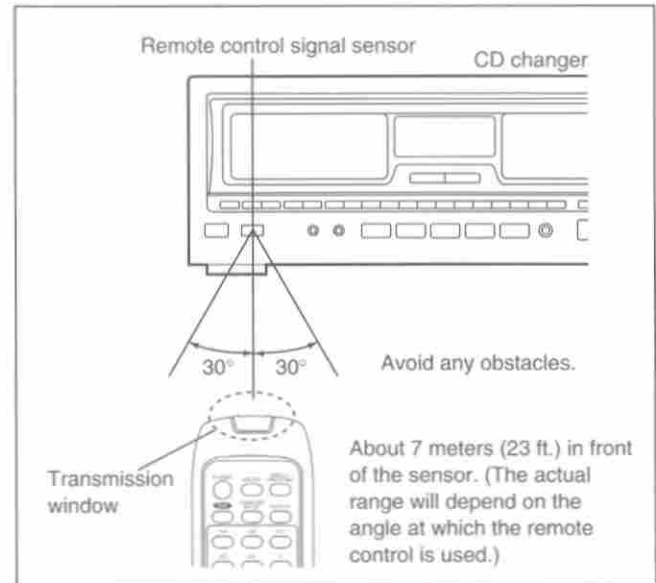

Note







Be sure the transmission window and the unit's sensor are free from dust. Excessive dust might affect performance.



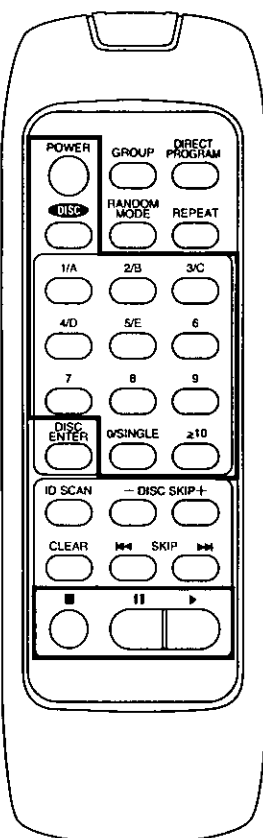

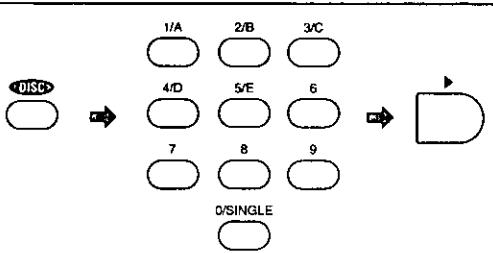
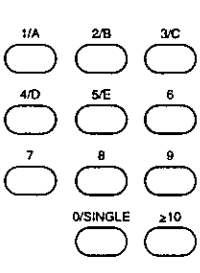
The operation may not be correct if direct sunlight or another strong light source strikes the receiving sensor of this unit. If there is a problem, place the unit away from the light source.

RQT3847-P

Quick reference table for remote control operation

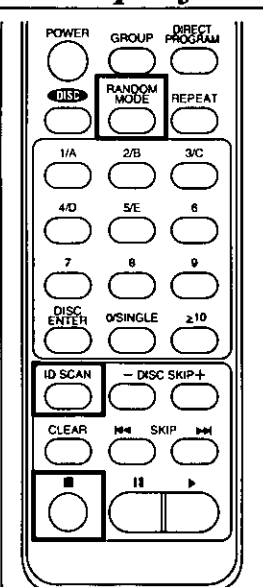
For details about each function, refer to the operating instructions for the main unit

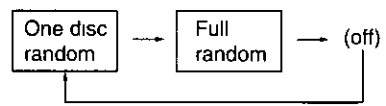
Basic operation		
	To turn OFF/ON the main unit	POWER 
	To select a specific disc	
	To select a specific track	 <p>To select a track between 1 and 9 Press the corresponding number on the keypad To select a two-digit track number 10 or higher First press ≥10, and then press the numbers for the two digits</p>
	To start play	
	To stop play temporarily	 Press ► button to resume play
	To stop play	

Random play/ID scan function		
	To start one disc/full random play	RANDOM MODE  Each time the button is pressed, the random mode will change in the following order 
	To stop random play	 This stops play and cancels random play at the same time
	To start ID scan	ID SCAN  Press ► when the desired track has been found

Program play

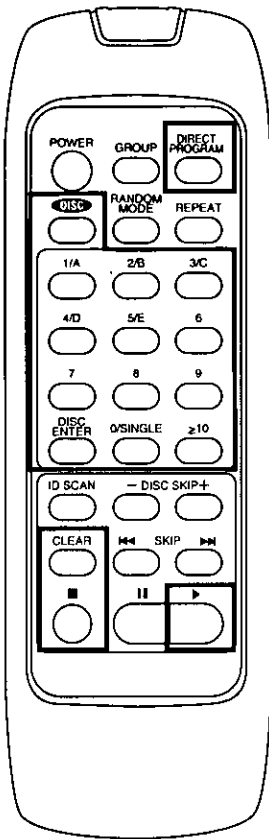

To start program play

①
(In the stop mode)
Select the program mode. (Press PROGRAM on the changer front panel.)

②

Select a disc.

③

Select a track.

Repeat steps ② and ③ until you have completed all entries.

④

Start play.

To clear a single item from the program

CLEAR
Only the selection which is currently displayed is cleared.

To clear all programmed contents

(In the stop mode)
■

To add the track currently being played to the program

(In the play mode)
DIRECT PROGRAM

Skip discs/skip tracks/repeat function, Single disc play

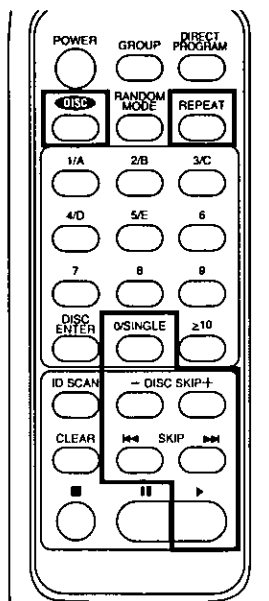

To skip discs

- DISC SKIP+

To skip tracks

SKIP

To repeat play

(Before or during play)
REPEAT
To cancel repeat mode. Press REPEAT again.

To play the disc in slot No.0

DISC → 0/SINGLE →

Disc grouping play

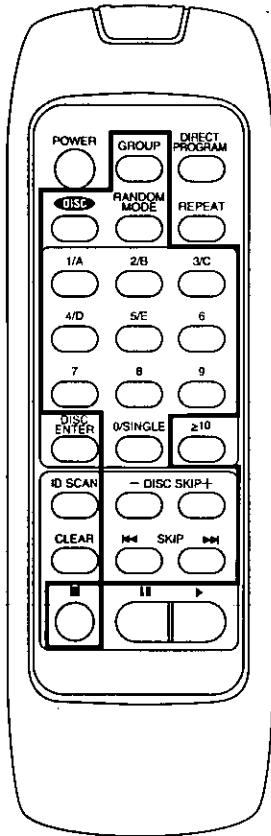

To group discs

① Select the disc number.

1/A 2/B 3/C

DISC → 4/D 5/E 6

OR

7 8 9

- DISC SKIP+ 0/SINGLE

② Select the group enter mode. (Press GROUP ENTER on the changer front panel.)

③ Select a group. Repeat steps ①, ② and ③ until you have completed all items.

GROUP → 1/A 2/B 3/C

4/D 5/E

To cancel discs from groups

Perform above steps ① and ②, and then select the group you want to cancel in step ③.

To cancel a particular disc from all groups, press in step ③ above.

To name groups

① Select the group naming mode. (Press GROUP ENTER on the changer front panel.)

② Call up the group name you want on the display.

SKIP →

③ Select the group you want to name.

GROUP → 1/A 2/B 3/C

4/D 5/E

For sequential play within a given group

GROUP → 1/A 2/B 3/C

4/D 5/E

Select the group you want.

For random play within a given group

① Select the group you want.

GROUP → 1/A 2/B 3/C

4/D 5/E

② Select the random mode.

RANDOM MODE

Troubleshooting guide

Problem	Probable cause(s)	Suggested remedy
The changer does not respond correctly to remote commands.	The batteries have run out.	• Replace batteries with new ones.
	There is an obstruction between the remote control and the changer.	• Remove the obstruction.
	The batteries are inserted incorrectly. [The (+) and (-) polarities are reversed.]	• Reinsert batteries so that the polarities are correct.